

acer



Acer Chromebook Spin 714

Acer Chromebook Enterprise Spin 714

USER'S MANUAL

© 2023. All Rights Reserved.

Acer Chromebook Spin 714 / Acer Chromebook Enterprise Spin 714

Covers: CP714-2W / CP714-2WN

This revision: March 2023



Important

This manual contains proprietary information that is protected by copyright laws. The information contained in this manual is subject to change without notice. Images provided herein are for reference only and may contain information or features that do not apply to your computer. Acer Group shall not be liable for technical or editorial errors or omissions contained in this manual.

Register your Acer product

Go to www.acer.com/register-product, and sign in or sign up your Acer ID to register your product.

Once it is done, you can review it under “My Products” page.

Model number: _____

Serial number: _____

Date of purchase: _____

Place of purchase: _____

Google and Google Play are trademarks of Google LLC.



The terms HDMI and HDMI High-Definition Multimedia Interface, and the HDMI Logo are trademarks or registered trademarks of HDMI Licensing Administrator, Inc. in the United States and other countries.

TABLE OF CONTENTS

Getting started	4		
Turn on your Chromebook.....	4	Touchpad.....	8
Select your language settings	4	Left view.....	9
Connect to a network.....	4	Right view	10
Accept the Terms of Service.....	4	USB 3.2 Gen 2 information.....	10
First-time sign-in.....	4	USB Type-C information	10
Create a new Google Account.....	4	Bottom view	11
Browse as a guest	4	Rechargeable Active Stylus	13
Your Acer Chromebook tour	5	Remove or insert the stylus	13
Front view.....	5	Usage Modes	14
Keyboard view.....	6	Frequently asked questions	15
Function keys.....	7	Get help or more information	16
Common keyboard shortcuts.....	7		

GETTING STARTED

Turn on your Chromebook

On the Chromebook, press the power button. A "Welcome" screen will appear when the Chromebook first boots up.

Select your language settings

Use the "Language" drop-down list to choose your default language setting. If there is more than one way to type in your language, you may be prompted to select a keyboard input method as well.

Connect to a network

Select a network from the "Connect to network" list to connect to the Internet. If network access is protected, you will need an access password to connect to it.

Accept the Terms of Service

Once connected to a network, accept the Terms of Service. Your Chromebook will then download any available system updates, so you automatically get the latest ChromeOS features.

First-time sign-in

Create a new Google Account

You can create a new Google Account if you don't already have one. Select **Create a Google Account** to set up a new account. A Google Account gives you access to useful web services developed by Google, such as Gmail, Google Drive, and Google Calendar.

Browse as a guest

You can also use the Chromebook without a Google Account by selecting **Browse as a Guest**.

YOUR ACER CHROMEBOOK TOUR

Front view

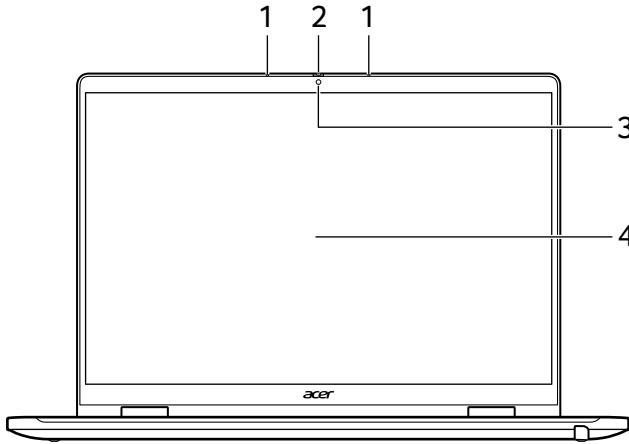

#	Icon	Item	Description
1		Microphones	Internal microphones for sound recording.
2		Webcam shutter	Slide the shutter to the left to cover the webcam. Slide right to open it.
3		Webcam	Web camera for video communication. <i>A light next to the webcam indicates that the webcam is active.</i>
4		Touchscreen	Displays Chromebook output, supports multi-touch input.



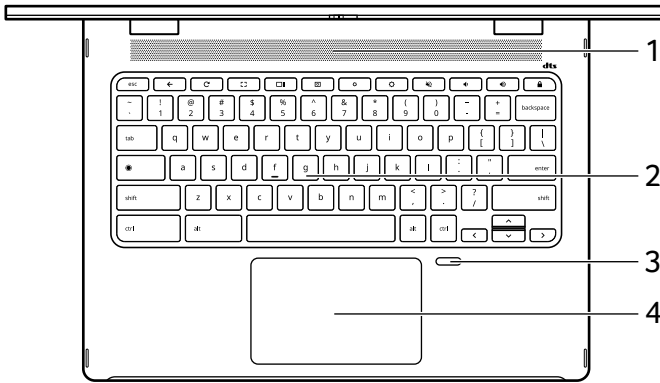







Keyboard view



#	Icon	Item	Description
1		Speaker	Deliver stereo audio output.
2		Keyboard	For entering data into your Chromebook.
3		Fingerprint reader (optional)	Fingerprint reader for unlocking your Chromebook.
4		Touchpad / click button	<p>Touch-sensitive pointing device which functions like a Chromebook mouse.</p> <p><i>Pressing down anywhere on the pad functions like the left button of a mouse.</i></p> <p><i>Pressing down anywhere with two fingers functions like the right button of a mouse.</i></p>



Function keys

The Chromebook uses function keys or key combinations to access some hardware and software controls, such as screen brightness and volume. The dedicated function keys each have a specific function.

Icon	Function	Description
	Previous	Go to the previous page.
	Reload	Reload the current page.
	Full-screen	Open the page in full-screen mode.
	Next window	Switch to the next window.
	Screenshot	Takes screenshot.
	Brightness down	Decreases the screen brightness.
	Brightness up	Increases the screen brightness.
	Mute	Turns off audio output.
	Volume down	Decreases the volume.
	Volume up	Increases the volume.
	Launcher	Launch the Apps panel.

Common keyboard shortcuts

You can use shortcuts to complete some tasks more quickly.

Keyboard shortcuts	Description
Ctrl + 	Takes screenshot.
Alt + 	Toggles caps lock.
Alt + 	Projects your screen.

Note: For a complete list of keyboard shortcuts, press **Ctrl + Alt + /**





Touchpad

The built-in touchpad is a pointing device that senses movement on its surface. This means the cursor responds as you move your fingers across the surface of the touchpad.

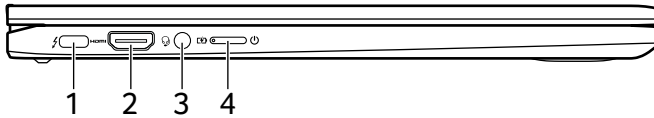
Action	Gesture
Click	Press down on any part of the touchpad.
Two-finger tap (or alt-click)	Tapping the touchpad with two fingers or pressing (and holding) Alt on the keyboard and tapping the touchpad with one finger both equal a "right-click" on a Chromebook mouse.
Two-finger swipe	Place two fingers on the touchpad and move them up and down to scroll vertically, left and right to scroll horizontally.
Drag and drop	Select the item you want to move with one finger. With a second finger, move the item. Release both fingers to drop the item. (This gesture works for files, not windows or icons.)



Left view



#	Icon	Item	Description
1		USB Type-C port with DC-in/Thunderbolt™ 4 port	Connects to the provided USB Type-C power adapter and to USB devices with a USB Type-C connector. Supports Thunderbolt™ 4 and displays.
2		HDMI port	Supports high-definition digital video connections.
3		Headset/speaker jack	Connects to audio devices (e.g., speakers, headphones), or a headset with microphone.
		Power button	Turns the Chromebook on and off.
4		Battery indicator	Indicates the Chromebook's battery status. Charging: The light shows amber when the battery is charging. Fully charged: The light shows blue when in AC mode.

Right view



#	Icon	Item	Description
1	+ / -	Volume control key	Adjusts the system volume.
2		USB port	Connects to USB devices.
3		USB Type-C port with DC-in/Thunderbolt™ 4	Connects to the provided USB Type-C power adapter and to USB devices with a USB Type-C connector. Supports Thunderbolt™ 4 and displays.

USB 3.2 Gen 2 information

- USB 3.2 Gen 2 compatible ports are blue.
- Compatible with USB 3.2 Gen 2 and earlier devices.
- For optimal performance, use USB 3.2 Gen 2-certified devices.
- Defined by the USB 3.2 Gen 2 specification (SuperSpeed USB).

USB Type-C information

- Supports DisplayPort™ audio/video output.
- Compatible with Thunderbolt™ 4.
- Delivers up to 3 A at 5 V DC for USB charging.
- DC-in: requires power adapter or power source providing 65 W at 5~20 V.

For optimal performance, please use a certified Acer power adapter or USB Power Delivery device.

Bottom view

CP714-2W

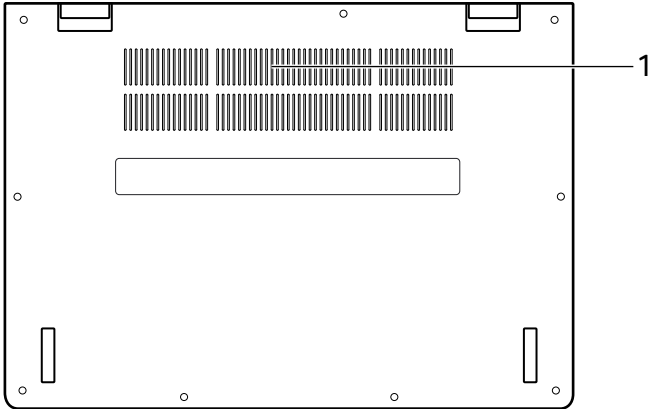

CP714-2WN

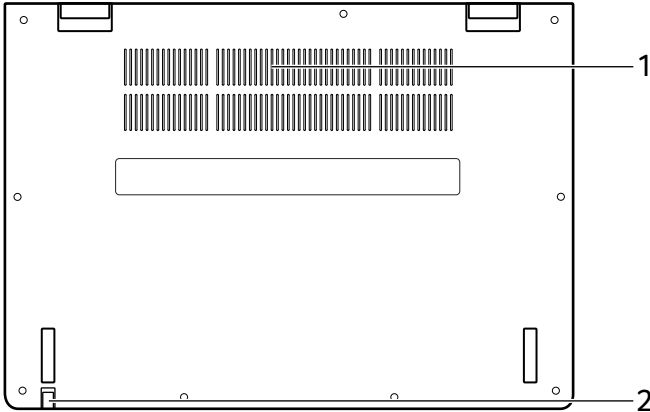

#	Icon	Item	Description
1		Ventilation and cooling fan	Allows the Chromebook to stay cool. <i>Do not cover or obstruct the openings.</i>

#	Icon	Item	Description
2		Stylus	Remove the pen from the slot and perform touch actions on the screen.

RECHARGEABLE ACTIVE STYLUS

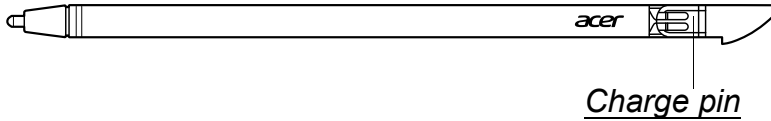

Charge pin

Insert the stylus into the slot completely to start charging.

15 minutes charging: provide 4 hours of usage.

- If you feel that the function is unstable, please insert the stylus into the slot to charge it.
- The pen will enter power-saving mode.
Idle: After 2 minutes, move the tip over the touchscreen to wake the pen.



Note

Function may differ depending on apps

Remove or insert the stylus

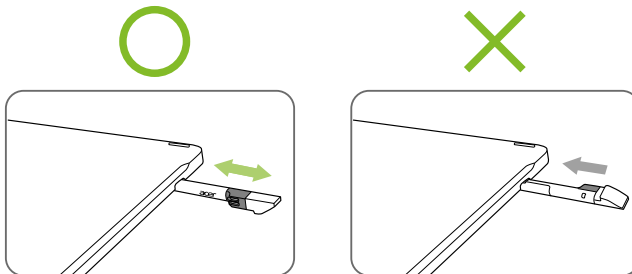

USAGE MODES

Your Chromebook features the following modes. You can choose a mode to fit your needs.

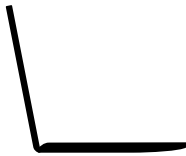

Laptop

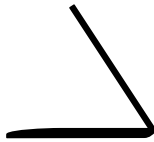

Display





Tent



Tablet

FREQUENTLY ASKED QUESTIONS

Question	Answer
What software works on a Chromebook?	Chromebooks use apps from the Google Play Store and on the web. There are apps to be productive, get creative, enjoy movies and shows, play games and more.
How do I get more apps?	You can get more apps from the Google Play Store  or the web.
Can I use Microsoft Office software?	Chromebooks work with Microsoft [®] Office. Whether it's Word, Excel [®] or PowerPoint [®] , you can easily find the apps on the web.
Where can I find my files?	All your files are stored in the Files app  . Find the app by clicking the Launcher icon  and searching "Files".
How do I transfer my local files?	Transfer your local files using a compatible storage device. Your Chromebook works with most external storage devices (e.g.: USB thumb drives, removable hard drives). You can also upload your files, photos, and videos to Google Drive. After setting up your Chromebook with your Google Account, you'll be able to access your files on Drive.
Why does my Chromebook need my Google Account information?	You'll use your Google Account to sign in to your Chromebook. It is the same account you use for Google services such as Gmail and Drive. Your Chromebook uses your account information to automatically sign you into apps and services.

Question	Answer
How do I set this up for my child?	If you want to set up parental controls for your child, it's important that you sign in using your child's personal Google Account. If they don't already have one, you can create one during the sign-in process on your Chromebook. You will be able to add your child's school account after you complete device onboarding.

Get help or more information

For information on:	Refer to:
Chromebook Help	Open the Explore app  on your Chromebook.
ChromeOS	google.com/support/chromebook/